

SIEMENS



Presentation example LFS1

LFS1...

Flame Safeguard

User Documentation

LFS1 and this User Documentation are intended for use by OEMs who integrate the LFS1 in their products



Note!

This documentation is only valid together with LFS1 data sheet N7782!

Smart Infrastructure

Contents

1	Supplementary documentation	3
2	Typographical conventions	4
2.1	Safety notes.....	4
2.2	Qualified personnel.....	4
2.3	Correct use.....	4
3	Warning notes	4
5	Connection BCI via integrated jack RJ11	6
5.1	Connection display and operating unit AZL2.....	6
5.2	Connection interface OCI400.....	7
5.3	Connection BC interface OCI410.....	7
6	Communication / parameterization	8
8	Operation via AZL2	9
8.1	Description of the unit / meanings of displays and buttons.....	9
8.2	Meaning of symbols on the display.....	10
8.3	Special functions.....	10
9	Operation	11
9.1	Normal display.....	11
9.1.1	Standby display.....	11
10	Menu-driven operation	13
10.1	Assignment of levels.....	13
11	Info level	14
11.1	Info level display.....	14
11.2	Display of info values.....	15
11.2.1	Identification date.....	15
11.2.2	Identification number (Reserved, currently not used).....	15
11.2.3	Burner identification.....	16
11.2.4	Number of startups resettable.....	17
11.2.5	Total number of startups.....	18
11.2.6	Flame relay (FR) switching cycles.....	19
11.2.7	Auxiliary relay (HR) switching cycles.....	21
11.2.8	'Maximum relay switching cycles' warning message.....	23
12.2	Display of service values.....	27
13.1	Entering the password.....	32
13.2	Changing the heating engineer's password.....	34
13.3	Changing the OEM password.....	36
14.1	Parameters without index, with direct display.....	38
14.2	Parameters with index, with or without direct display.....	40
16	Parameter list (AZL2)	50
17	List of figures	52

1 Supplementary documentation

Product type	Title	Type of documentation	Documentation number
LFS1	Flame Safeguard	Data sheet	N7782
AZL21 / AZL23	Display and operating units	Data sheet	N7542

2 Typographical conventions

2.1 Safety notes

This User Documentation contains notes which must be observed to ensure your personal safety and to protect from material damage. The instructions and notes are highlighted by warning triangles or a hand symbol and are presented as follows, depending on the hazard level:



Warning means that death, severe personal injury or substantial damage to property **can** occur if adequate precautionary measures are not taken.



Note draws your attention to **important information** about the product and its handling, or the relevant part of the documentation requiring particular attention.

2.2 Qualified personnel

Only **qualified personnel** are allowed to commission and operate the equipment. Qualified staff in the context of the safety-related notes contained in this user documentation are persons who are authorized to commission, ground and tag devices, systems and electrical circuits in compliance with established safety practices and standards.

2.3 Correct use

Note the following:

The equipment may only be used for the applications described in the technical documentation and only in conjunction with devices or components from other suppliers that have been approved or recommended by Siemens.

The product can only function correctly and safely if shipped, stored, set up and installed correctly, and operated and maintained with care.

3 Warning notes



Warning!
All safety, warning and technical notes contained in the LFS1 Data Sheet N7782 also apply to this document!

To avoid personal injury or damage to property or the environment, the following warning notes must be observed.

The LFS1 is a safety device! Do not open, interfere with or modify the equipment. Siemens does not assume responsibility for damage resulting from unauthorized interference!

4 Commissioning notes

After installation and commissioning of a plant, the parameterized values and settings must be **documented** by the person/heating engineer responsible for the plant. The documentation must be checked by the expert and then kept in a safe place.



Warning!

On the OEM access level of the LFS1, it is possible to make parameter settings that differ from application standards. When setting the parameters, it is important to ensure that the application will run safely in accordance with legal requirements.

If this is not observed, there is a risk of loss of safety functions.

Prior to commissioning, the following points must be checked:

- That all parameters are set correctly
- The correct function of the flame detector in the event of
 - loss of flame during operation (including the response time **tab**)
 - extraneous light during the extraneous light detection phase in the test.
This means that terminal 6 of the LFS1 is inactive.

5 Connection BCI via integrated jack RJ11

- The AGV50 signal cable for the AZL2 or other accessories, for example BC interface OCI410 (plugs into the jack RJ11), must be connected or disconnected only when the unit is dead (all-polar disconnection), since the BCI does not ensure safe separation from mains voltage
- The display and operating unit AZL2 is designed for direct connection to the integrated jack RJ11 on the LFS1 via signal cable AGV50
- Since the BCI has no safe separation from mains voltage, the signal cable AGV50 must conform to certain specifications. Siemens has specified the signal cable AGV50 for use under the burner hood, see Data Sheet N7782 - refer to the chapter *Technical data*. When using other signal cables, it is not guaranteed that Siemens' requirements will be met
- Do not lay the signal cable AGV50 from the LFS1 to the AZL2 together with other cables (especially high-voltage ignition cables)
- Both the signal cable AGV50 and the AZL2 must be shipped and stored so that no damage due to dust and water can occur when used in the plant later on
- To ensure protection against electric shock hazard, make certain that, prior to switching on the mains power, the signal cable AGV50 is correctly connected to the AZL2
- The AZL2 must be used in a dry and clean environment

5.1 Connection display and operating unit AZL2

Connect the AZL2 with the BCI on your LFS1 via signal cable AGV50 as shown in the following figure.

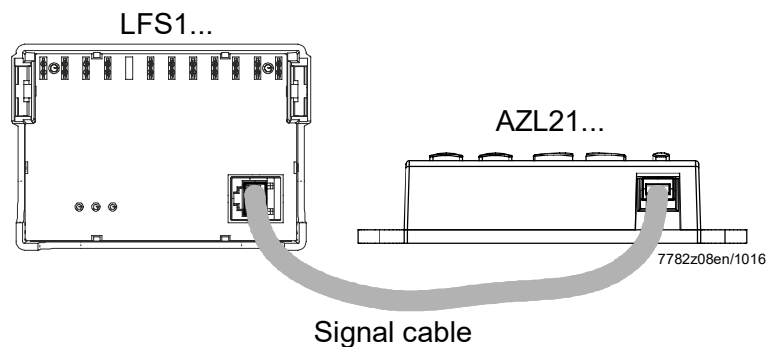

Figure 1: Connection display and operating unit AZL2

5.2 Connection interface OCI400

- Put the interface OCI400 in the connector on the lockout reset button of the LFS1. Interface diagnostics only works if the AGK20 lockout reset button extension is not fitted.
- Connect the interface OCI400 without any other extension to the interface on your PC according to the sample configuration shown below

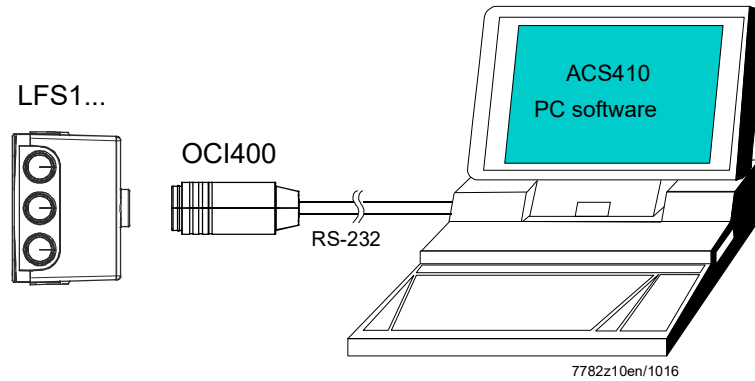

Figure 2: Connection interface OCI400

5.3 Connection BC interface OCI410

Connect the BC interface OCI410 without any other extension to the USB interface on your PC as shown in the following figure.

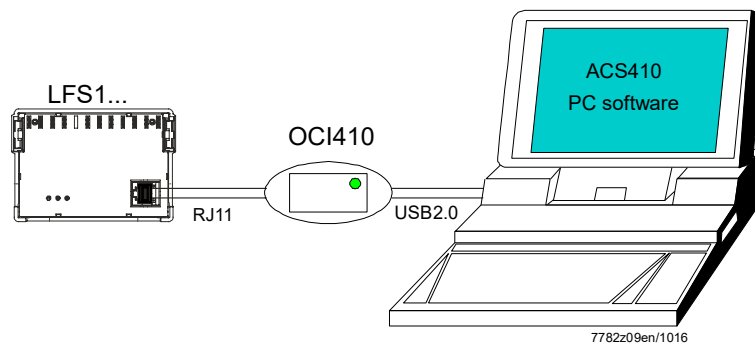

Figure 3: Connection BC interface OCI410

6 Communication / parameterization

AZL2

The display and operating unit AZL2 has an LCD and features menu-driven operation, offering simple operation, parameterization and targeted diagnostics. When performing diagnostics, the display shows the operating statuses, the flame signal amplifier, and the startup counter (number of switching cycles). Passwords protect the different parameter levels of the burner/boiler manufacturer and heating engineer against unauthorized access. Simple settings that the plant operator can make on site do not require a password.

7 Display and operating units

Display and operating unit **AZL21.00A9**

Article no.: **BPZ:AZL21.00A9**

Detached unit for a choice of mounting methods, with 8-digit LCD, 5 buttons, BCI interface for LFS1, degree of protection IP40

Refer to Data Sheet N7542.



Display and operating unit **AZL23.00A9**

Article no.: **BPZ:AZL23.00A9**

Detached unit for a choice of mounting methods, with 8-digit LCD, 5 buttons, BCI interface for LFS1, degree of protection IP54

Refer to Data Sheet N7542.



Accessories

Signal cable **AGV50.100**

Article no.: **BPZ:AGV50.100**

For AZL2, with RJ11 connector, cable length 1 m, pack of 10

Signal cable **AGV50.300**

Article no.: **BPZ:AGV50.300**

For AZL2, with RJ11 connector, cable length 3 m, pack of 10



8 Operation via AZL2

8.1 Description of the unit / meanings of displays and buttons

The function and operation of unit versions AZL21 and AZL23 are identical.

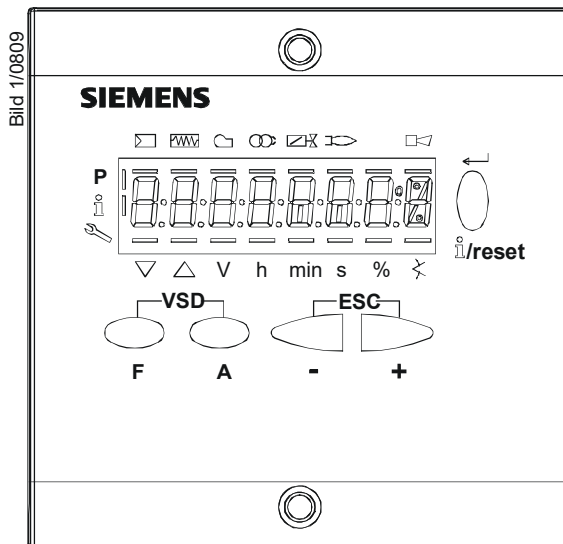

Figure 4: Description of the unit / meanings of displays and buttons

Button	Function
	A and F button: Parameterized function - For switching to parameter setting mode P (press and simultaneously)
	Info and Enter button - For navigation in info and service mode * For selection (symbol flashing) (press button for <1 second) * For changing to a lower menu level (press button for 1...3 seconds) * For changing to a higher menu level (press button for 3...8 seconds) * For changing to the normal display (press button for >8 seconds) - Enter in parameter setting mode - Reset in the event of fault - One menu level down
	- button - For decreasing the value
	+ button - One menu level down - Increase value
	+ and - button: Escape function (press button and simultaneously) - No adoption of value - One menu level up

8.2 Meaning of symbols on the display

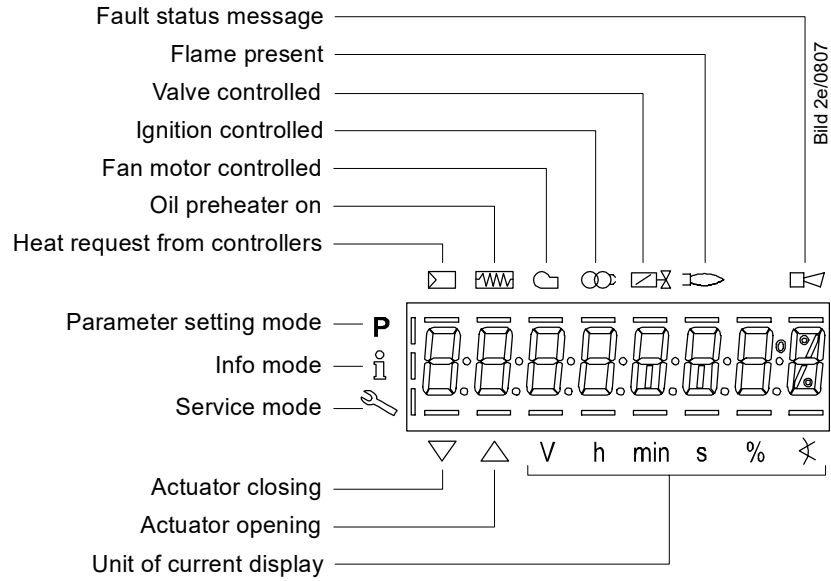



Figure 5: Meaning of display

8.3 Special functions

8.3.1 Manual locking



/reset

and other button

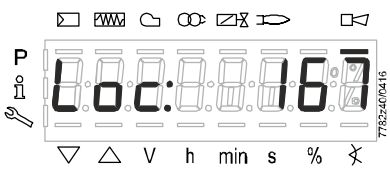

Press  together **with any other button**.
The basic unit switches instantly to the lockout position, no matter what the operating position.

The display shows the fault status message.
Example: Error code **167**
(Refer to chapter *Error code list!*)

The reset must be carried out as follows:



/reset
1 s

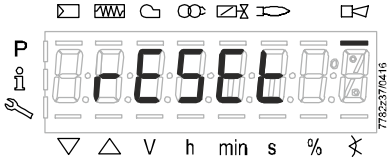

When  is pressed for 1 second, **rESEt** appears on the display.

When the button is released, the basic unit is reset.

9 Operation

9.1 Normal display

Normal display is the standard display in normal operation, representing the highest menu level. From the normal display, you can change to the info, service or parameter level.

9.1.1 Standby display

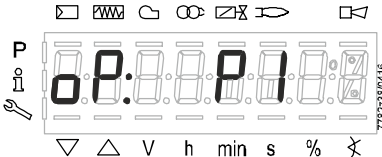

The device is in standby mode and is waiting for a flame signal, i.e. the NC contact is closed, the NO contact is open

9.1.2 Operating position display

9.1.2.1. Phase display

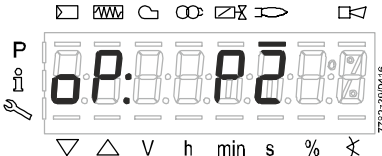

The device is in operating position, the flame signal has been detected and the NC contact is open, the NO contact is closed depending on terminal 6.
The bar below the symbol for flame appears.

9.1.2.2. List of the phase display

Phase	Function
Ph01	Undervoltage
oP: P1	Standby, wait for a flame signal
oP: P2	Status information, flame ON

Table 1: Phase list

9.1.3 Fault status message, display of errors and info

9.1.3.1. Display of errors (faults) with lockout

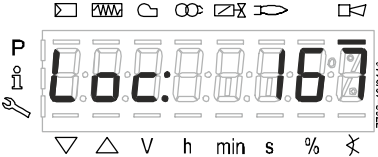

The display shows **Loc.**. The bar under the fault status message  appears.

The unit is in the lockout position.

The current error code is displayed (refer to Error code list).

Example: Error code **167**

9.1.3.2. Reset



When  is pressed for 1 second, **rESEt** appears on the display.

When the button is released, the basic unit is reset.

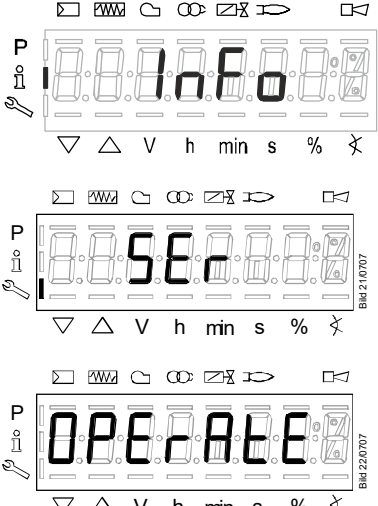

If  is pressed for longer than 3 seconds, **InFo**, **SEr** and **OPeArTE** appear on the display one after the other.

When the button is released, the basic unit is reset.



Note!

For the meaning of the error and diagnostic codes, refer to the error list in the chapter *Error history*. When an error has been acknowledged, it can still be read out from the error history.

10 Menu-driven operation

10.1 Assignment of levels

The various levels can be accessed via different button combinations. The parameter level can only be accessed with a password.

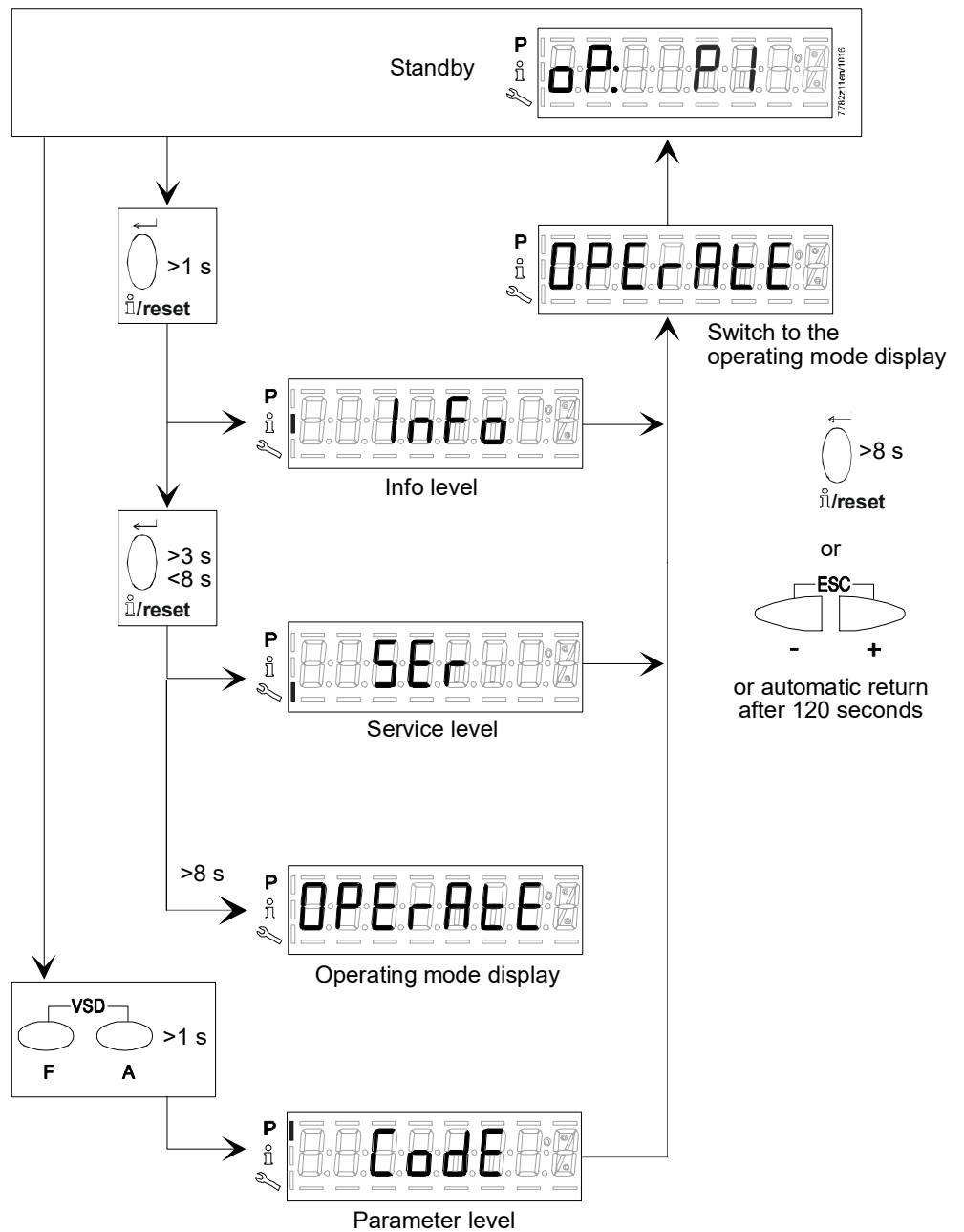
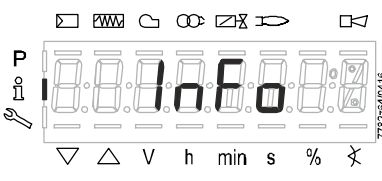



Figure 6: Assignment of levels

11 Info level

11.1 Info level display





 /reset
1...3 s



Press  until **InFo** appears.

When the  key is released, you are on the info level.



The info level displays information about the basic unit and operation in general.

 **Note!**

On the info level, you can press  or  to display the next or the previous parameter.

On the info level, you can also press  for <1 second instead of .

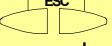
 **Note!**



Press  -  or  for > 8 seconds to return to the normal display.

 **Note!**

No change in value on the info level.

If **._._** is displayed by the parameter, the value may consist of more than 5 digits.

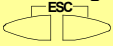
Pressing  for >1 second and <3 seconds displays the value.

Pressing  for >3 seconds or pressing  -  takes you back to the parameter number selection (parameter number flashes).

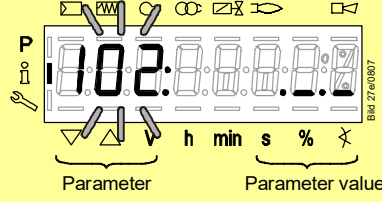
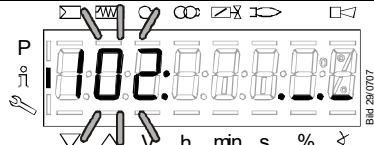

Figure 7: Info level

11.2 Display of info values

11.2.1 Identification date

The identification date described below corresponds to the creation date for the program sequence and cannot be changed by the user.



On the left, parameter **102**: is displayed flashing.
On the right, **._._** is displayed.

Example: **102**: **._._**

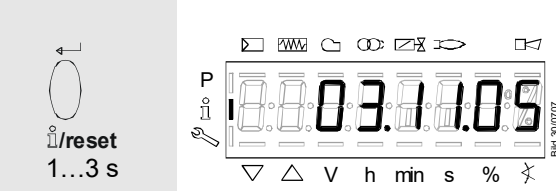

Pressing the  (1...3 seconds) and releasing it when **._._** flashes displays the identification date (creation date of the program sequence) **DD.MM.YY**.

Example: Identification date **03.11.05**

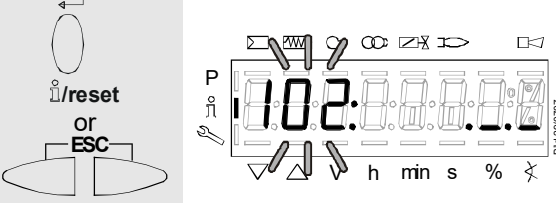

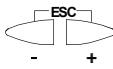
Press  or  to return to the display of parameters.

To the next parameter 

11.2.2 Identification number (Reserved, currently not used)

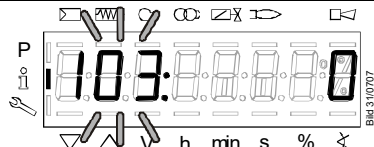

On the left, parameter **103**: is displayed flashing.
On the right, identification number **0** appears.

Example: **103**: **0**

To the next parameter   or  < 1 s

 Back to the previous parameter

11.2.3 Burner identification

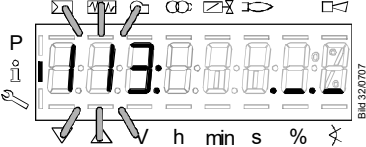

On the left, parameter **113**: is displayed flashing.
On the right, **._.** appears

Example: **113**: **._.**

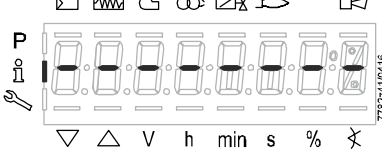



Pressing the  **i/reset** button (1...3 seconds) and releasing it when **._.** flashes displays the burner ID.

Factory setting: -----

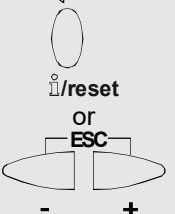
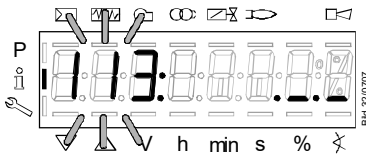
Note!
The burner ID can only be changed with the help of the PC software ACS410 and only on parameter level.

Press  **i/reset** or  **ESC** to return to the display of parameters.

To the next parameter  **+**

 **-** Back to the previous parameter

11.2.4 Number of startups resettable

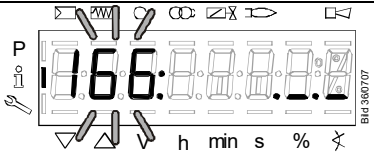

		<p>On the left, parameter 164: is displayed flashing. On the right, ._. appears.</p> <p>Example: Parameter 164: ._.</p>
<p>/reset 1...3 s</p>		<p>Pressing the /reset button (1...3 seconds) and releasing it when ._. flashes displays the number of startups (can be reset).</p> <p>Example: 000036</p>
<p>/reset 3...8 s</p>		<p>Press /reset (1...3 seconds) to go to the range that can be changed</p> <p>The number 0 flashes</p>
<p>/reset</p>		<p>Press /reset to reset the number of startups to 0.</p> <p>Display: 000000</p>
<p>/reset or ESC</p> <p>- +</p>		<p>Press /reset or - + to show parameter 164 flashing again.</p>
<p>To the next parameter</p>	<p>+</p>	<p>- Back to the previous parameter</p>

11.2.5 Total number of startups



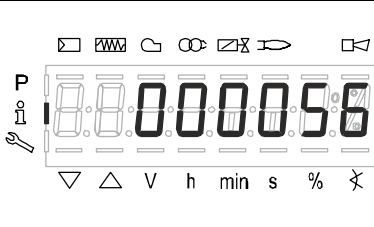

On the left, parameter **166**: is displayed flashing.
On the right, **. _ _** appears.

Example: Parameter **166**: **. _ _**

Pressing the /reset button (1...3 seconds) and releasing it when **. _ _** flashes displays the total number of startups.

Example: **000056**

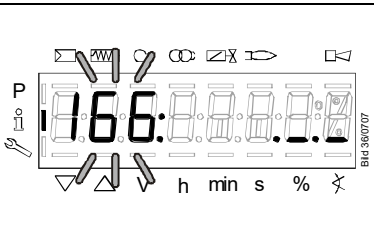
Press /reset or  - + to go back to the display of parameters.

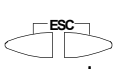
To the next parameter

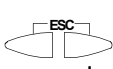

Back to the previous parameter

11.2.6 Flame relay (FR) switching cycles

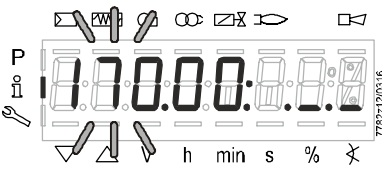

On the left, the current parameter **170.** is shown flashing.
Index **00**: does not flash.

._._ is displayed on the right.

Example:
Parameter **170.**, index **00**: . _ . _



/reset 1...3 s

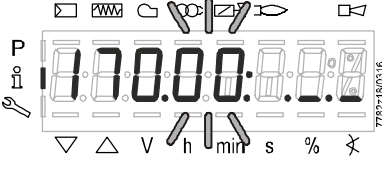

Pressing the **/reset** button (1...3 seconds) and releasing it when **00** flashes displays the index **00**: for flame relay switching cycles flashing.

Display: Parameter **170.** does not flash, index **00**: flashes, . _ . _ does not flash.

To the next index

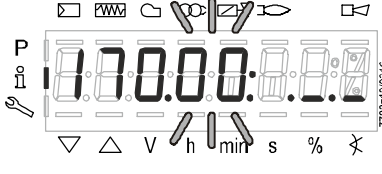



Index **00** is the basic screen. **- +** can be used to select the desired index.

- .00 = Flame relay (FR) switching cycles
- .01 = Auxiliary relay (HR) switching cycles
- .02 = Free
- .03 = Free



/reset 1...3 seconds



Pressing the **/reset** button (1...3 seconds) and releasing it when . _ . _ flashes displays the number of flame relay (FR) switching cycles

Display: Value **0000305**

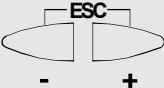

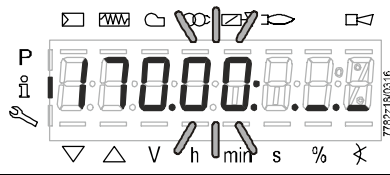

Press  - + to return to the index.

Display: Parameter **170**. does not flash, index **00**: flashes, **.-.-** does not flash.

To the next index



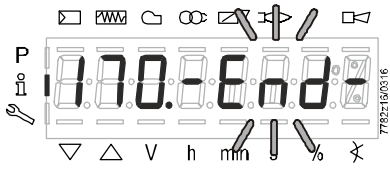

Back to the previous index

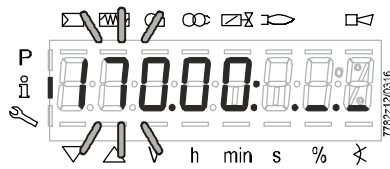
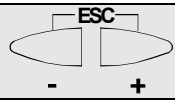

When this display appears, you have reached the end of the index level within parameter **170**.

Display **- End -** appears flashing.



Press  - + to return to the info level.

Display: Parameter **170**. flashes, index **00**: and **.-.-** do not flash.

To the next parameter



Back to the previous parameter

11.2.7 Auxiliary relay (HR) switching cycles

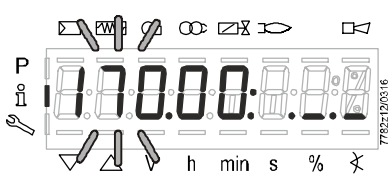

On the left, the current parameter **170.** is shown flashing.
Index **00**: does not flash.

·-·- is displayed on the right.

Example:
Parameter **170.**, index **00**: ·-·-



/reset 1...3 s

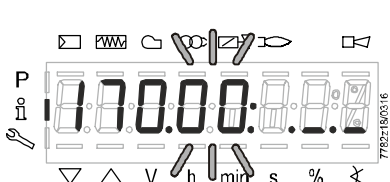

Pressing the **/reset** button (1...3 seconds) and releasing it when **00** flashes displays the index **00**: (for flame relay switching cycles) flashing.

Display: Parameter **170.** does not flash, index **00**: flashes, ·-·- does not flash.

To the next index



+



+

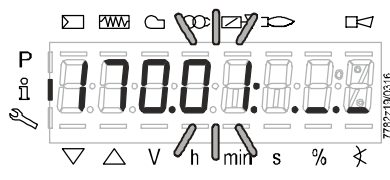

Press **+** to select index **.01**.

- .00 = Flame relay (FR) switching cycles
- .01 = Auxiliary relay (HR) switching cycles
- 02 = Free
- 03 = Free

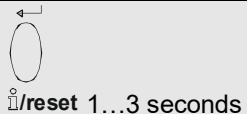

/reset 1...3 seconds

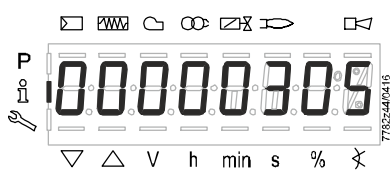

Pressing the **/reset** button (1...3 seconds) and releasing it when **·-·-** flashes displays the number of auxiliary relay (HR) switching cycles.

Display: Value **00000305**

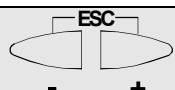

ESC

- **+**

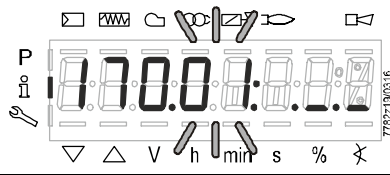

Press  - + to return to the index.

Display: Parameter **170**. does not flash, index **01**: flashes, **:-:-** does not flash.

To the next index



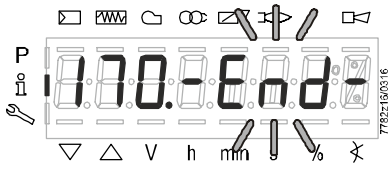

Back to the previous index

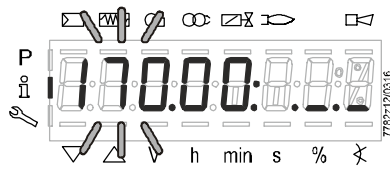
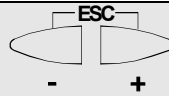

When this display appears, you have reached the end of the index level within parameter **170**.

Display **- End -** appears flashing.



Press  - + to return to the info level.

Display: Parameter **170**. flashes, index **00**: and **:-:-** do not flash.

To the next parameter



Back to the previous parameter

11.2.8 'Maximum relay switching cycles' warning message

The LFS1s are designed for switching cycles of up to 1,000,000. This maximum number of switching cycles is largely determined by the two relays (HR / FR). As described in Chapter 11.2.7 "Auxiliary relay (HR) switching cycles", the switching cycles of both relays (HR / FR) are counted and the counter values are stored under parameters 170.00 and 170.01.

The LFS1 also has a permanently programmed parameter 171 with the value 1,000,000, known as the warning threshold. As soon as one of the two parameters 170.00 or 170.01 has reached the number of switching cycles specified in parameter 171, a warning message can be activated by pressing the lockout reset button (EK). To activate the warning message, the lockout reset button (EK) must be pressed and held for >10 seconds until the LED briefly lights up yellow. The current basic color of the LED (e.g., green for flame signal) is now replaced by fast yellow blinking. This means that if the 1 million switching cycles was exceeded at one of the relays (HR / FR), the current basic color is displayed alternately for approx. 3.5 seconds and then fast yellow blinking for approx. 1.2 seconds.

If the relays (HR / FR) are physically intact at this time, this warning message has no effect on the operation of the LFS1. By pressing the lockout reset button (EK) again for >10 seconds, this warning message can be deactivated and the basic color (e.g., green for flame signal) is displayed again.

The warning message can only be activated or deactivated using the lockout reset button (EK) on the LFS1, not by the AZL2. The LFS1 is delivered with the warning message deactivated as standard, but it can be activated manually as described above.

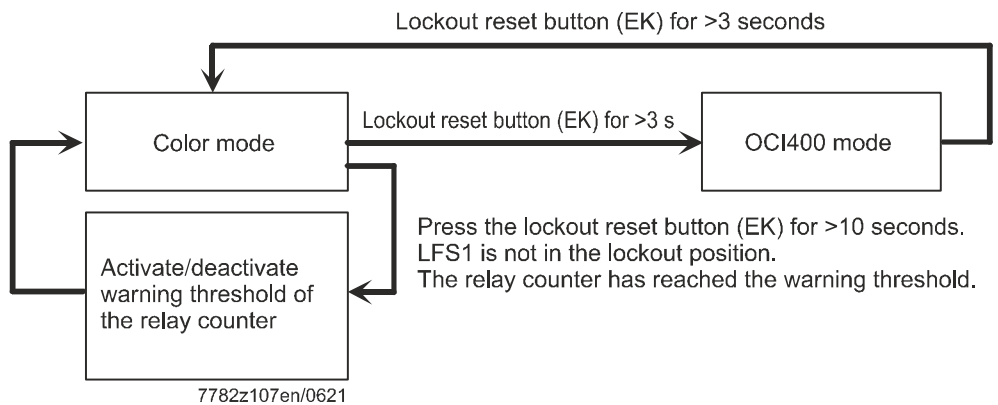
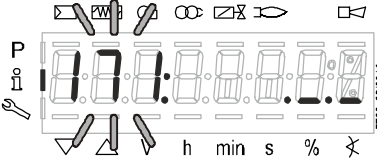

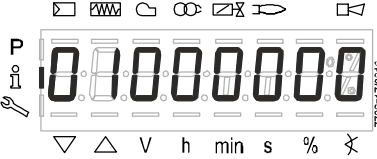

Figure 8: Activation/deactivation of the warning message for the relay switching cycles (HR / FR)

11.2.9 Warning threshold: 1 million switching cycles





On the left, parameter **171**: is displayed flashing.
On the right, **._._** appears.

Example: Parameter **171**: **._._**

Pressing the **reset** button (1...3 seconds) and releasing it when **._._** flashes displays the fixed value **01000000** as the warning threshold for 1 million switching cycles.

Display shows **01000000**

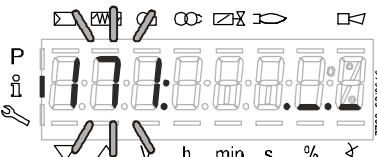
Press **reset** or **ESC** to go back to the display of parameters.





End of info level **-End-** **+** **-** Back to the previous parameter

11.2.10 End of info level

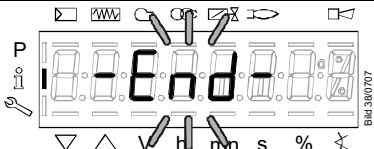

When this display appears, you have reached the end of the info level.

Display **– End –** appears flashing.

To the first parameter on the info level  **+**

To the final parameter on the info level  **-**

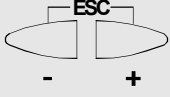



or

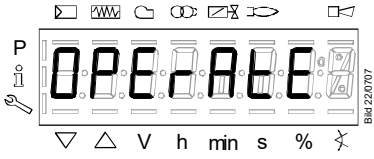

/reset
>8 s

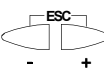

Press  **-** **+** or  **/reset** (>8 seconds) to return to operating mode display.

The display shows **OPERAtE**.

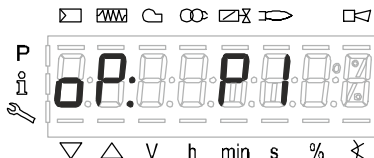

When this display appears, you are back to standby and you can change to the next level mode.



/reset

Press  **/reset** to switch between the service and the parameter level.

12 Service level

The service level is used to display information about errors including the error history.



Note!
When on the service level, you can press or to display the next or the previous parameter.
Instead of pressing + , you can also press for <1 second.



Note!
Press - or for > 8 seconds to return to the normal display.

12.1 Service level display



Press for >3 seconds until **SEr** appears.

When the is released, you are on the service level.

12.2 Display of service values

12.2.1 Error history



Note!

Can be deleted for service (refer to chapter *Parameter list*)!

Refer to chapter *Error code list*!

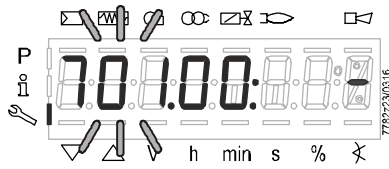

Parameter **701.00** is the basic screen.

On the right, error code - is displayed. The dash means that there is currently no error present.

Display: Parameter **701.** flashes, index **00:** and error code - do not.

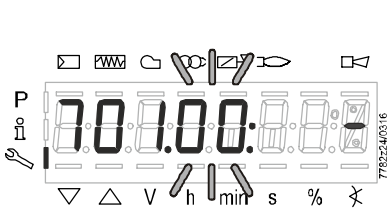

Pressing the  button (1...3 seconds) and releasing it when **00** flashes displays the index **00:** for the current error code flashing.

Display: Parameter **701.** does not flash, index **00:** flashes, error code - does not flash

To the next index

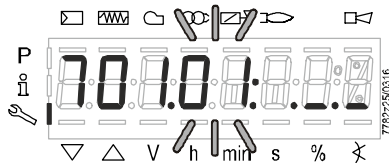

Press  to select index **01** for the startup meter reading.

- .00 = error code
- .01 = startup meter reading
- .02 = MMI phase
- .03 = free

Example:

Parameter **701.**, index **01.**, diagnostic code **._._**

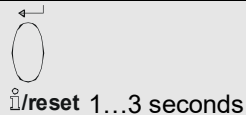

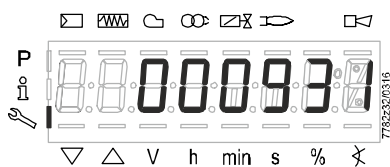

Pressing the  reset button (1...3 seconds) and releasing it when **._._** flashes takes you to the display mode.

Display: Value **000931**

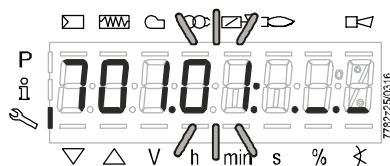
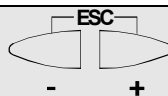

Press  to return to the index.

Display: Parameter **701.** does not flash, index **01:** flashes, **.-.-** does not flash.

To the next index



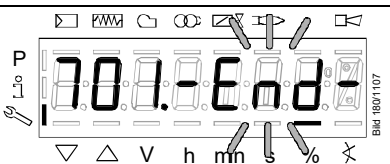

Back to the previous index

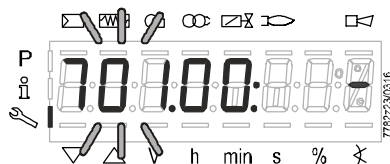
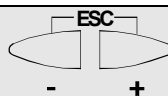

When this display appears, you have reached the end of the index level within parameter **701.**

Display **- End -** appears flashing.



Press  to return to the parameter level.

Display: Parameter **701.** flashes, index **00:** and diagnostic code **-** do not.

To the next oldest error

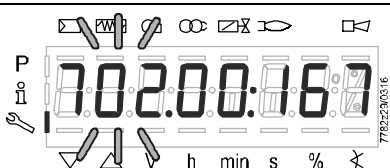

Parameters cover the period back to the last error since deletion of the history (max. to parameter **702.**)

Example:
Parameter **702.**, index **00:**, error code **167**

To the next parameter



Back to the previous parameter

12.2.2 Flame intensity

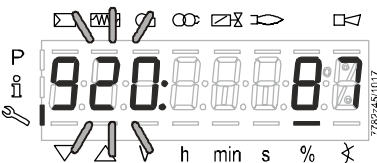

The parameter **920**: is shown flashing.

On the right, the intensity of the flame is displayed as a percentage (%)

Example: **920: 87**

To the next parameter



Back to the previous parameter

12.2.3 Parameter without function on the LFS1



The parameter **936**: is shown flashing, but is without function on the LFS1.

To the next parameter



Back to the previous parameter

12.2.4 Mains voltage

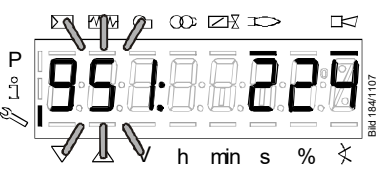

The parameter **951**: is shown flashing.

The mains voltage is displayed on the right in volts

Example: **951: 224**

To the next parameter



Back to the previous parameter

12.2.5 Flame intensity

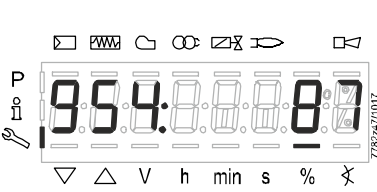

The parameter **954**: is shown flashing. It corresponds to parameter 920.

On the right, the intensity of the flame is displayed as a percentage (%).

Example: **954: 87**

End of service level -End-



Back to the previous parameter

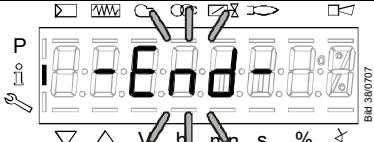

12.2.6 End of service level



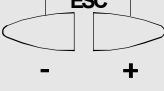

When this display appears, you have reached the end of the service level.

Display **– End –** appears flashing.

At the start of the service level to the first parameter  **+**  To the final parameter on the service level **-**

Press  **ESC**  to return to the operating mode display.

The display shows **OPErAtE**.

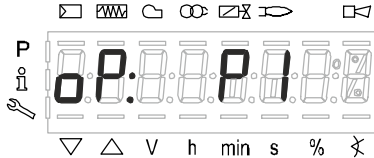

When this display appears, you are back to standby and you can change to the next level mode.

13 Parameter level

The parameters stored in the basic unit can be displayed or changed on the parameter level. The change to the parameter level requires entry of a password. Siemens supplies the LFS1 with the factory settings as specified in the type summary.

The OEM can change the Siemens default settings to meet its own requirements via parameterization.

With the LFS1, the burner control's characteristics are determined primarily through parameterization. Every time the unit is recommissioned, the parameter settings must be checked. The LFS1 must never be transferred from one plant to another without adapting the parameters to the new plant.



Caution!

Parameters and settings may only be changed by **qualified personnel**. If parameters are changed, responsibility for the new parameter settings is assumed by the person who – in accordance with the access rights – has made parameter changes on the respective access level.

After parameterization, the OEM must check to ensure that safe burner operation is guaranteed. The OEM that carried out the settings is always responsible for the parameters, their settings and compliance of the respective application with the relevant national and international standards and safety regulations, such as EN 676, EN 267, EN 1643, EN 746-2 etc. If this is not observed, there is a risk of loss of safety functions.

Siemens, its suppliers and other Group companies of Siemens AG do not assume responsibility for special or indirect damage, consequential damage, other damage, or damage resulting from wrong parameterization.



Warning!

If the factory settings are changed, all changes made must be documented and checked by the OEM.

The OEM is obliged to mark the unit accordingly and to include at least the list of device parameters and settings in the burner's documentation.

Siemens also recommends attaching an additional mark on the LFS1 in the form of an adhesive label. As specified in EN 298, the label should be easy to read and wipe proof.

The label with a maximum size of 70 mm x 45 mm can be attached to the upper part of the housing.

Example of label:

OEM logo
Type / part no.: 1234567890ABCD
CAUTION! OEM settings:
Parameter no.
182 = 1 flame sensitivity
217.00 = 1 s flame signal flame-on response time
217.01 = 3 s flame signal flame-out response time

13.1 Entering the password



Note!
The **OEM** password must consist of **5** characters, the **heating engineer** password must consist of **4** characters.

Press the button combination to display **Code**.

When the buttons are released, 6 bars appear with the first one flashing.

Press to select a number or letter.

Press to confirm the value.
The value entered changes to a minus sign (-).
The next bar flashes.

Press to select a number or letter.

After the final character is entered, the password must be confirmed with .

Press to end the password entry.

Example: Password consisting of 5 characters.

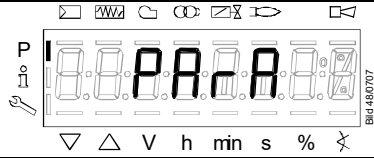

PArA appears for a maximum of 2 seconds to confirm that the password has been entered correctly.



Note!

For the entry of passwords or burner IDs, the following numbers and letters can be used:









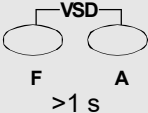
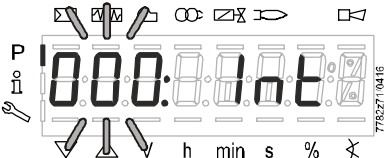
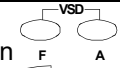

	= 1		= A		= L
	= 2		= b		= n
	= 3		= C		= o
	= 4		= d		= P
	= 5		= E		= r
	= 6		= F		= S
	= 7		= G		= t
	= 8		= H		= u
	= 9		= I		= Y
	= 0		= J		

13.2 Changing the heating engineer's password

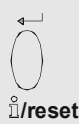
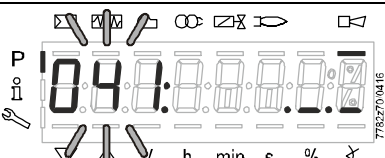

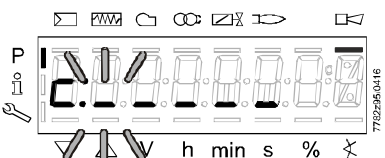
Note!

To change the heating engineer's password as OEM, the OEM password must be entered for **c**!

		<p>After pressing the key combination  and entering the OEM password,  and  +  can be used to select parameter group 000: Int.</p> <p>Pressing the  takes you to parameter 041 heating engineer's password.</p>
		<p>Parameter 041: flashes.</p> <p>Press  to go to level c: for password changes.</p>
		<p>Letter c: for confirm appears flashing.</p> <p>Proceed as described in chapter <i>Entering the password</i> and enter the former password.</p> <p>After the final character is entered, the password must be confirmed with .</p>
		<p>Letter n: for new appears flashing.</p> <p>Proceed as described in chapter <i>Entering the password</i> and enter the new password (4 characters).</p> <p>After the final character is entered, the password must be confirmed with .</p>

 /reset

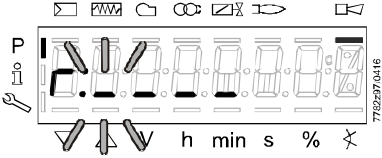

Letter **r**: for repeat appears flashing.

Proceed as described in chapter *Entering the password* and repeat the entry of the new password.

After the final character is entered, the password must be confirmed with  /reset.

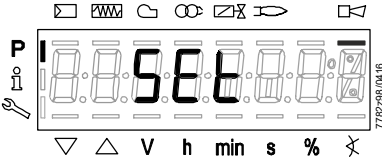

SEt confirms that the new password has been saved.

You will then be taken automatically to the next menu display **000: Int.**

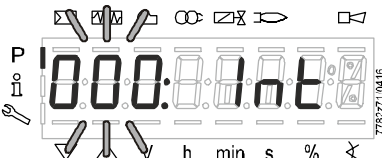









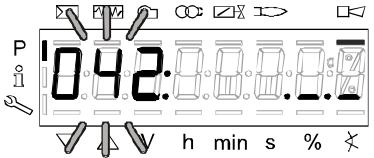

Pressing the  /reset button takes you to parameter **041** heating engineer's password.

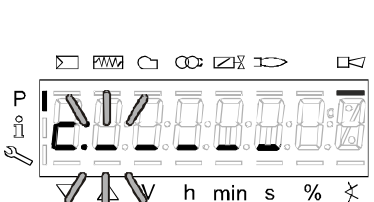
Continue in the parameter level to the next parameter group **100**:

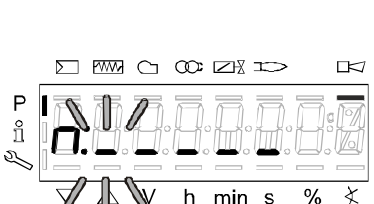
 +

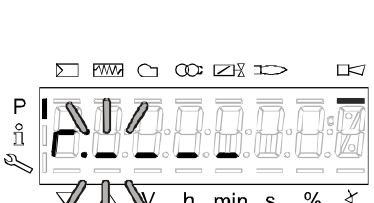

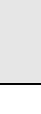

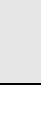
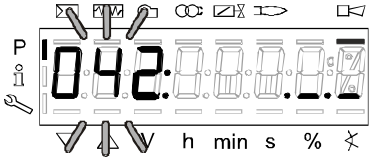

 - **End-**

13.3 Changing the OEM password

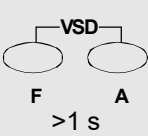
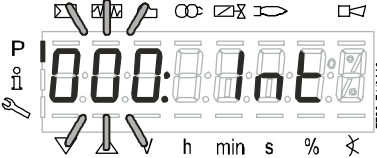
		<p>Parameter 042: flashes.</p> <p>Press /reset to go to level c: for password changes.</p>
		<p>Letter c: for confirm appears flashing.</p> <p>Proceed as described in chapter <i>Entering the password</i> and enter the former password.</p> <p>After the final character is entered, the password must be confirmed with .</p>
		<p>Letter n: for new appears flashing.</p> <p>Proceed as described in chapter <i>Entering the password</i> and enter the new password (5 characters).</p> <p>After the final character is entered, the password must be confirmed with .</p>
		<p>Letter r: for repeat appears flashing.</p> <p>Proceed as described in chapter <i>Entering the password</i> and repeat the entry of the new password.</p> <p>After the final character is entered, the password must be confirmed with .</p>
		<p>SEt confirms that the new password has been saved.</p>
		<p>Parameter 042: flashes again.</p>

14 Operating variants of the parameters

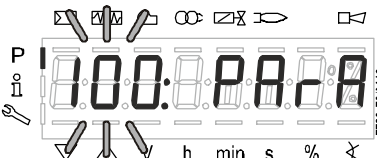
The parameters stored in the LFS1 flame safeguard can be displayed and changed on the parameter level.

		<p>After pressing the key combination  and entering the OEM password,  and  + can be used to select parameter group.</p>
		<p>With  + , select the parameter group 100: PArA.</p> <p>Pressing the /reset button takes you to parameter 182: Flame sensitivity.</p>

14.1 Parameters without index, with direct display

14.1.1 Example based on parameter 182 (flame sensitivity) on the parameter level

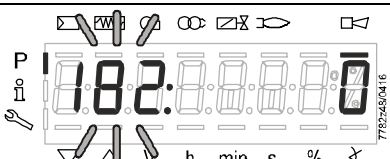

 +





Press  + to select the flame sensitivity.

Display: Parameter **182**: flashes, value **0** does not.

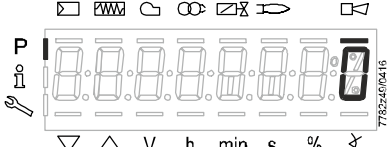

 /reset

 or 





Press  or  to go to editing mode.

Display: **0**

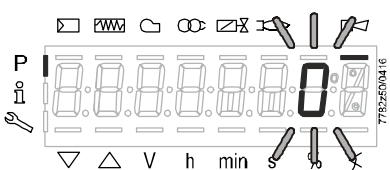

 or 





Press  or  to shift the former flame sensitivity one place to the left in editing mode.

Display: Flame sensitivity **0** flashes

Note!
To detect display errors, the value appears one place shifted to the left.

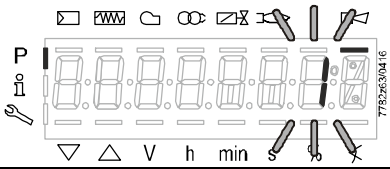
 or 



Press  or  to set the desired flame sensitivity.

Display: Flame sensitivity **1** flashes

Alternative 1:

Discard the change!

 - +

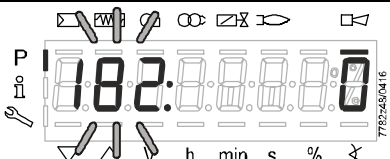

Alternative 2:

Adopt the value!

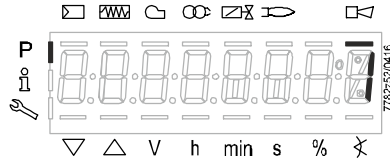
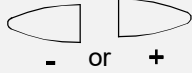
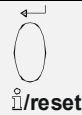

Press or to return to editing mode.

The set value is adopted.

Note:
To detect display errors, the value is shown again, but shifted one place to the right.

Display: Value 1

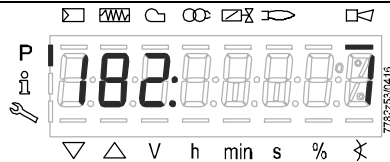
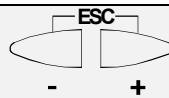

End of parameter group 100
-End-



End of parameter group 100
-End-

Or:

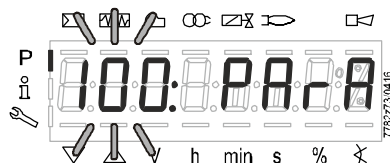
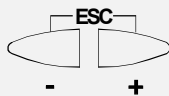
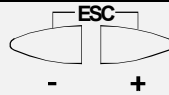











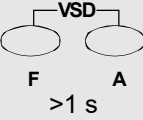
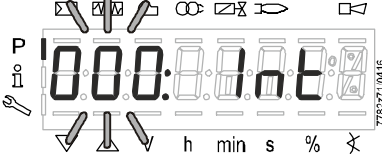
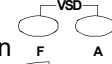

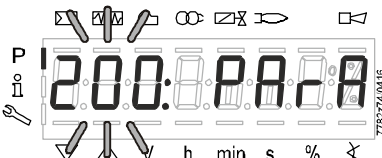

Press to return to the parameter group **100: PARa**.

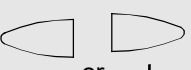
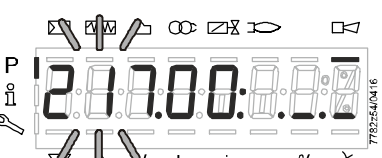
Press to go to the next parameter group.

Example: **200:** Flame safeguard

14.2 Parameters with index, with or without direct display

14.2.1 Example based on parameter 217.00 (flame-on response time) and 217.01 (flame-out response time) in the parameter level

		<p>After pressing the key combination  and entering the OEM password,  and  + can be used to select parameter group 000: Int.</p> <p>With  + , select the parameter group 200: PArA.</p>
		<p>With  + , select the parameter group 200: PArA.</p> <p>Pressing the  /reset button takes you to parameter 217.00: Flame-on response time.</p>
		<p>Press  or  to select the parameter 217.00.</p> <p>On the left, the flame-on response time 217. is shown flashing. Index 00: does not flash.</p> <p>The flame-on response time ._._ is shown on the right. Dot-dash means that the value has too many characters for the current display.</p> <p>Display: Parameter 217. flashes, index 00: and ._._ do not.</p>
 /reset 1...3 s		
		<p>Press  /reset (1...3 seconds) to display index 00: for the flame-on response time.</p> <p>Display: Parameter 217. does not flash, index 00: flashes, reaction time ._._ does not flash.</p>
To the next index		 Back to the previous index

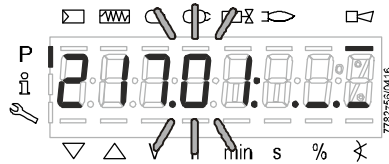

Press to select index **01** for the flame-out response time.

.00 = Flame-on response time
.01 = Flame-out response time

Example:
Parameter **217.**, index **01.**, flame-out response time **.01**

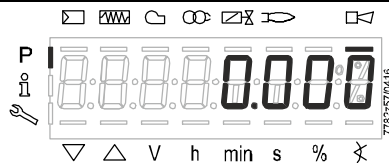
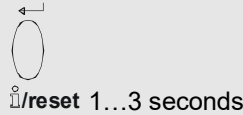

Press to go to the display mode.

Display: Value **0.000**

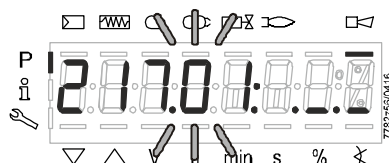
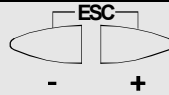

Press to return to the index.

Display: Parameter **217.** does not flash,
index **01**: flashes, **-.-** does not flash.

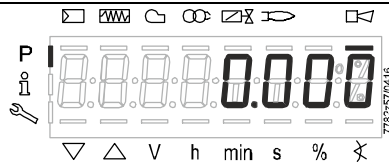

Press or to go to editing mode.

Display: **0.000**

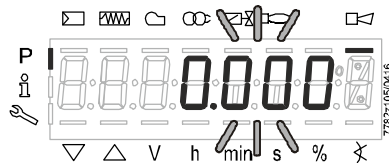
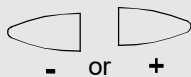

Press or to shift the former flame-out response time one place to the left in editing mode.

Display: Flame-out response time **0.000** flashes

Note!
To detect display errors, the value appears one place shifted to the left.

Press - or + to set the desired flame-out response time.

Display: Flame-out response time **0.147** flashes

Alternative 1:

Discard the change!

Alternative 2:

Adopt the value!

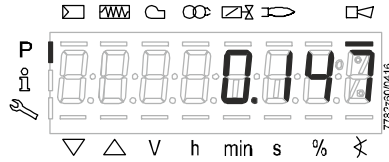
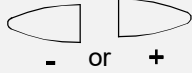

Press or to return to editing mode.

The set value is adopted.

Note!

To detect display errors, the value is shown again, but shifted one place to the right.

Display: Value **0.147**

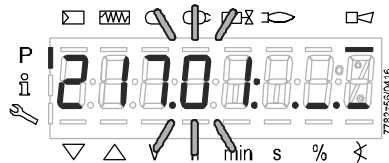
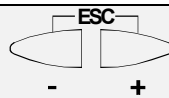

To the next index



Back to the previous index

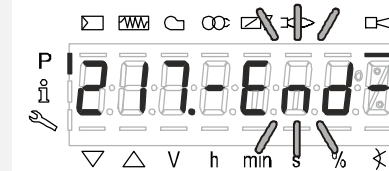

When this display appears, you have reached the end of the index level within parameter **217**.

Display **-End-** appears flashing.

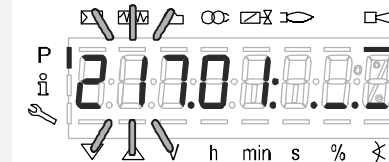
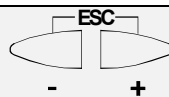

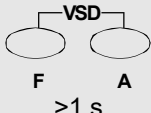

14.2.2 Example based on parameter 699.00 (gradient flame signal display ionization) and parameter 699.01 (gradient flame signal display QRA / RAR) in the parameter level

Parameter 699... can be used to set the gradient of the signal on the 0-10 volt voltage output on terminal 7 of the LFS1 (for details, also refer to Data Sheet N7782).

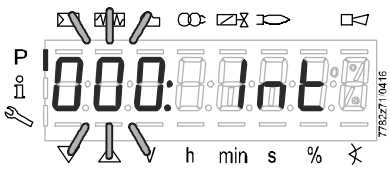

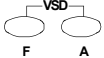

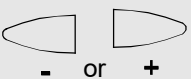

After pressing the key combination  and entering the OEM password,  and  can be used to select parameter group **000: Int.**

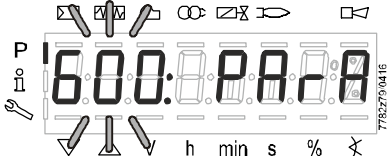



Press  or  to select parameter group **600: PArA.**



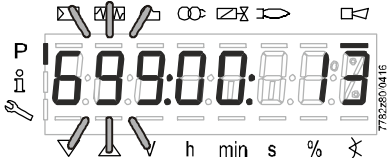

Pressing the  button takes you to parameter **699.00: Flame display gradient ionization**

On the left, parameter number **699.** is shown flashing. Index **00:** does not flash.

Gradient **13** is shown on the right.

Example:
Parameter **699.**, index **00.**, gradient **13**





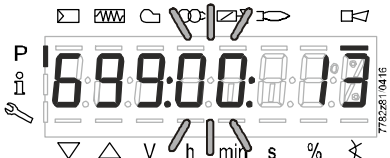





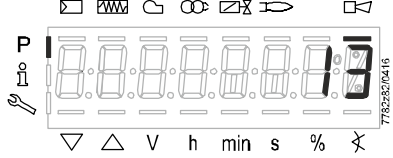

When  is pressed, index **00:** for flame display gradient ionization is shown flashing.





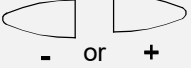

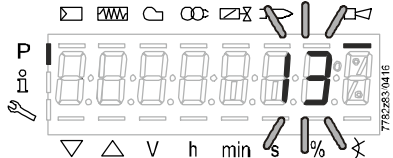
Display: Parameter **699.** does not flash, index **00:** flashes, gradient **13** does not flash



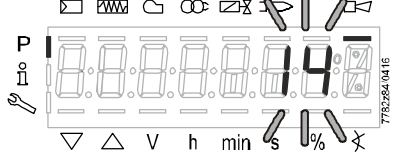

 Press  to display value **13** for flame display gradient ionization.

Editing mode  Editing mode

 or 

 Press  or  to access the editing mode and the previous value is shifted one place to the left
 Display: Value **13** flashes

 or 

 Set the desired gradient with  or .
 Example: Set value 14 with .
 Display: Flame display gradient **14** flashes

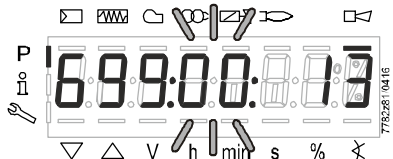
Alternative 1:

Discard the change! 



Alternative 2:

Adopt the value!

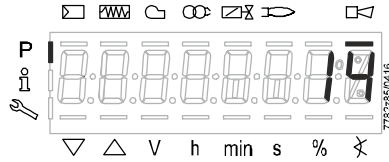
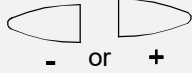

Press or to return to editing mode.

The set value is adopted.

Note!

To detect display errors, the value is shown again, but shifted one place to the right.

Display: New value **14**

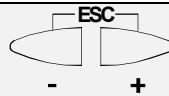

To the next index



Back to **699.-End-**

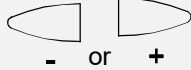

When or is pressed, the index **01:** for flame display gradient QRA and RAR is shown flashing.

Display: Parameter **699.** does not flash, index **01:** flashes, gradient **16** does not flash.

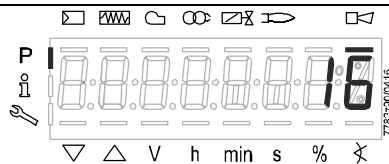
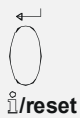



Press to display value **16** for flame display gradient.

Editing mode



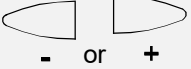
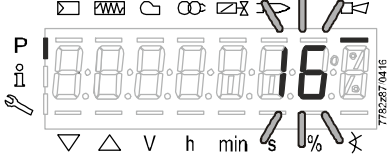

Editing mode



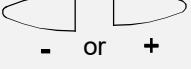
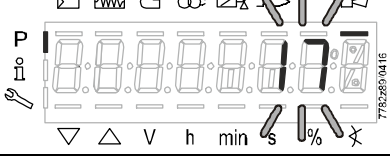

Press  or  to access the editing mode and the previous value is shifted one place to the left.

Display: Value **16** flashes

Set the desired gradient with  or  .

Example: Set value 17 with  .

Display: Flame display gradient **17** flashes

Alternative 1:

Discard the change!

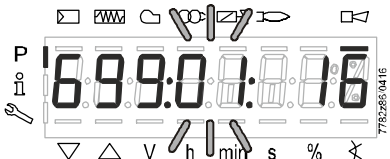

Alternative 2:

Adopt the value!

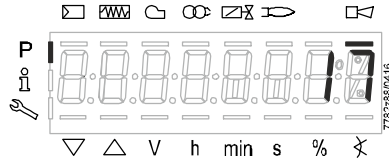
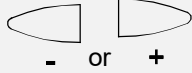

Press or to return to editing mode.

The set value is adopted.

Note!

To detect display errors, the value is shown again, but shifted one place to the right.

Display: New value **17**

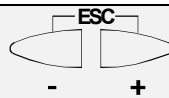

End of parameter group 600

-End-



Back to the previous index

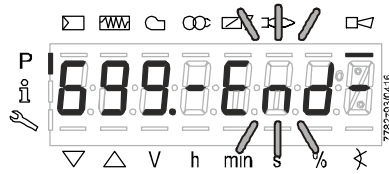

When this display appears, you have reached the end of the index level within parameter **699**.

Display **-End-** appears flashing.

15 Error code list

Error code	Clear text	Possible cause
Loc: 10	Various errors Internal error	<ul style="list-style-type: none">• Wiring error or internal error• Glare on flame detector RAR e.g. with artificial light• Short circuit on the connecting terminals of the UV flame detector QRA in operating level (terminal 6 on the LFS1 active)
Loc: 167	Manual locking active	Locking triggered via AZL2 with a key combination

16 Parameter list (AZL2)

Abbreviations for password level:

HF	Heating engineer
OEM	Manufacturer of the original product

Parameter number	Parameter	Editing	Value range		Increment	Default setting	Password level reading from level	Password level writing from level
			Min.	Max.				
0...	Internal parameter							
41	Heating engineer (HF) password (4 characters)	Selectable	XXXX	XXXX	1	---	---	OEM
42	OEM password (5 characters)	Selectable	XXXXX	XXXXX	1	---	---	OEM
60	Free	---	---	---	---	---	---	---
100...	General							
102	Identification date	Read only	---	---	---	---	Info	---
103	Identification number	Read only	0	9999	1	0	Info	---
113	Burner identification	AZL2: Readable ACS410: Selectable	0	99999999	1	---	Info	HF
164	Number of startups resettable	Resettable	0	999999	1	0	Info	Info
166	Total number of startups	Read only	0	999999	1	0	Info	---
170.00	Flame relay (FR) switching cycles	Read only	0	99999999	1	0	Info	---
170.01	Auxiliary relay (HR) switching cycles	Read only	0	99999999	1	0	Info	---
170.02	Free	---	---	---	---	---	---	---
170.03	Free	---	---	---	---	---	---	---
171	Warning message for when the maximum number of relay switching cycles (HR / FR) is reached	Read only	0	---	---	1000000	Info	---
182	Flame sensitivity	Selectable	0	3	1	0	OEM	OEM
200...	Flame safeguard							
217.00	Flame signal flame-on response time	Selectable	0 s	11.907 s	0.147 s	0 s	OEM	OEM
217.01	Flame signal flame-out response time	Selectable	0 s	11.907 s	0.147 s	0 s	OEM	OEM
600...	Voltage output							
699.00	Flame 1 flame display gradient (ionization)	Selectable	5	35	1	13	HF	HF
699.01	Flame 2 flame display gradient (QRA2 / RAR9)	Selectable	5	35	1	16	HF	HF

Parameter list LFS1... (continued)

Parameter number	Parameter	Editing	Value range		Increment	Default setting	Password level reading from level	Password level writing from level
			Min.	Max.				
700...	Error history							
701	Latest error in the history							
	00: Error code	Selectable	2	255	1	---	Service	---
	01: Startup meter reading	Selectable	0	99999	1	---	Service	---
	02: MMI phase	Selectable	---	---	---	---	Service	---
	03: Free	Selectable	0%	100%	1	---	Service	---
• • •								
702	Oldest error in the history							
	00: Error code	Selectable	2	255	1	---	Service	---
	01: Startup meter reading	Selectable	0	99999	1	---	Service	---
	02: MMI phase	Selectable	---	---	---	---	Service	---
	03: Free	Selectable	0%	100%	1	---	Service	---
900...	Process data							
920	Flame intensity:							
	Ionization	Read only	0%	100%	1%	---	Service	---
	QRA	Read only	0%	100%	1%	---	Service	---
	RAR	Read only	0%	100%	1%	---	Service	---
936	Not used with LFS1	---	---	---	---	---	---	---
951	Mains voltage	Read only	0 V	LFS1.xxA1: 155 V LFS1.xxA2: 290 V	1 V	---	Service	---
954	Flame intensity: (corresponds to parameter 920)							
	Ionization	Read only	0%	100%	1%	---	Service	---
	QRA	Read only	0%	100%	1%	---	Service	---
	RAR	Read only	0%	100%	1%	---	Service	---

Note on parameter 920 / 954!



Using parameter 920 / 954, the flame intensity can be displayed as a percentage (%) in the service menu of the display and operating unit AZL2. Only one flame signal can be displayed. This means that if an ionization probe and a QRA are being used at the same time (e.g., pilot burner supervision with ionization probe and main burner supervision with QRA), then the flame intensity which was detected first will be displayed.

17 List of figures

Figure 1: Connection display and operating unit AZL2.....	6
Figure 2: Connection interface OCI400	7
Figure 3: Connection BC interface OCI410	7
Figure 4: Description of the unit / meanings of displays and buttons	9
Figure 5: Meaning of display.....	10
Figure 6: Assignment of levels.....	13
Figure 7: Info level	14
Figure 8: Activation/deactivation of the warning message for the relay switching cycles (HR / FR)	23